

MADE IN USA



**NEW
PRODUCT**

MAX 1700 FS

Fail Safe

High Traffic Commercial
Brushless DC Slide Gate Operator
The Maximum Level of Gate Control



True Security... DSP Motion Control... High Performance

SAFETY SENSORS REQUIRED FOR UL 325 2016



MAX 1700 FS

FEATURE LIST:

MECHANICAL SPECIFICATIONS

- Max 1700 FS Slide Gate Operator dimensions (18.3 W x 24.5 D x 21.3 H) 18.5 arm height
- Heavy duty direct drive gear box 20: 1 Size 60
- Max 1700 FS capacity 1700lbs /60ft long gate speed 12” per second adjustable UL class I, II, III, IV
- Direct gear drive (no internal chains, belts, or pulleys)
- Corrosion protection gold zinc coating
- ✔ Continuous cycle at extreme temperature ranges. Overheating not possible
- ✔ Intelligent ramp-up and ramp-down gate speed control for smooth operation
- Shipping weight of Max Slide Gate Operator: Max 1700 FS (158 lbs)
- ✔ Programmable virtual OPEN & CLOSE limit (Limits auto-set in the event of a total power loss)

ELECTRICAL SPECIFICATIONS

- ✔ Mechanical Release: Local switch, keypad, or any dry contact relay will release dynamic braking, allowing gate to be pushed back in case of emergency (see page 4)
- ✔ Brushless DC motor equivalent to 1 1/4 HP AC motor
- ✔ Programmable gate speed controls, 16 selectable speeds
- ✔ Automatic gate position reset requires optional magnets and sensors or when using virtual limits, positive stops on both gate directions
 - Modular system design for ease of service
 - Switchable 115/230 voltage selection
- ✔ Adaptive DSP control for advanced brushless DC motion control
- ✔ Real time performance analyzer and event log (OBD PORT and Black Box) 8000 events including the history of error failure
- ✔ Low voltage wiring capabilities for remote power up 500 ft (no battery needed)
- ✔ ‘Solar Ready’ battery module with built-in advanced solar regulator
- ✔ Intelligent power management system with energy saver mode
 - Built-in 12vdc and 24vdc outputs
- ✔ Gold contact input connections and automobile grade connectors
 - Selectable open timer 0 to 60 seconds with ‘timer off’ option
- ✔ -4F to 165F (-20C to +74C) operational temperature range including battery performance without needing a heater
- ✔ Robust lightning protection up to 20KVolts and 10KAmps on all inputs and outputs (44 channels) including loop detector input connections
- ✔ Tunable 16 position safety obstruction sensor, auto adaptable to gate weight and size

✔ = Unique to Max Slide Gate Operator Series

- ✔ Dual motor overcurrent safety shut off for additional protection
 - This operator includes a Max BC-7 battery module providing minimum 100 cycles in case of power failure
- ✔ Three modes of selectable battery backup functions
- ✔ State machine design electronics with ultra-fast microprocessor
 - On-board three button station

SECURITY SPECIFICATIONS

- ✔ High traffic intuitive loop management system for better security
- ✔ Advanced security features with built-in audible and remote alarms
 - Magnetic lock control relay outputs with selectable delay times
- ✔ Tamper-alert relay output triggers “on” if gate is forced open
- ✔ Audible alarm if gate is tampered with or ERD is triggered for higher security
- ✔ Gate partial open recorder. Programmable inputs allow partial open cycles for high traffic gates while providing complete open cycles for emergency vehicles
 - Lockable cover with key lock release to prevent intruders and vandalism
- ✔ Built-in transaction buffer for high security 8000 events as well as error messaging file
- ✔ Gate status outputs for gate monitoring
- ✔ Advanced anti-tailgate feature provides higher security
- ✔ Optional Chain Drop Sensor detects unauthorized chain drops if you will use magnets option
- ✔ Fire Department Compliance allows gate to auto-open upon loss of AC power or battery depletion
- ✔ Mechanical release, see page 4 for detailed description of mechanical release

SAFETY SPECIFICATIONS

- ✔ Adaptive obstruction sensor for much better gate safety system. 16 selectable sensitivity settings
- ✔ UL 325/991 compliant Class I, II, III, and IV. CSA approved
- ✔ Dynamic magnetic brake system stops the gate immediately to prevent damage to obstructions
 - Built-in advanced entrapment protection and alarm output
 - Built-in gate-in-motion alarm for industrial applications

✔ = Unique to Max Slide Gate Operator Series

MAX 1700 FS

High Traffic Commercial Brushless 24 V DC Sliding Gate Operator-

Fail safe, back drivable manual operation upon loss of AC power or battery depletion

- Local keyed manual disconnect - allows gate to be pushed back
- Remote keyed manual disconnect - allows gate to be pushed back from outside the property by keypad or any dry contact command
- Dynamic braking system, in closed position, will fight back if unauthorized push back is attempted.
- Audible alarm and relay out trigger when unauthorized entry (push back) is attempted
- 25 ft #40 Nickel Plated Chain & Brackets
- Programmable virtual limit
- **Optional magnetic limits sensors available**
- **Patent No. US 9,406,207 B2**

Input AC Power/Amps - Switchable: 115VAC / 6 Amp, Single Phase
or 230AVC / 2 Amp, Single Phase



Jog Switch

- If the Battery Backup is set to one time open or leave open, the operator's braking system will be released allowing the gate to be pushed back in case of catastrophic failure.
- The Electronic Gate Open / Close is used to disengage the operator's braking system for 15 minutes with local key or remote key switch wired into the jog inputs on the motor controller.
- The Gate Shut-Off Switch can also disengage the operator's braking system for 15 minutes.
- After 15 minutes gate operator returns to normal operation.

Gate
Shut-Off
Switch

Alarm
Reset
Button

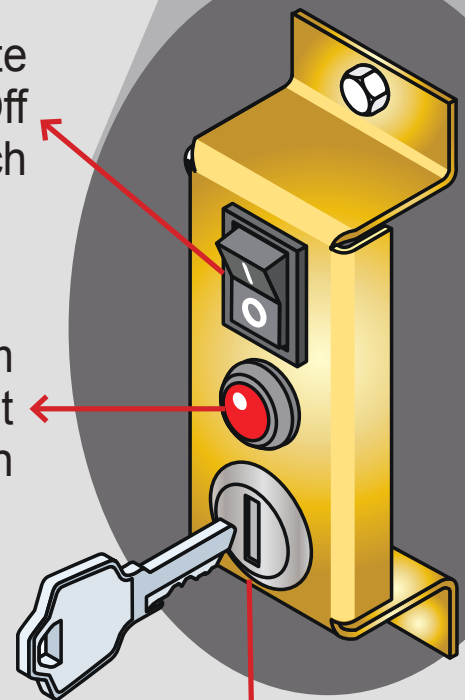

Electronic Gate
OPEN/CLOSE

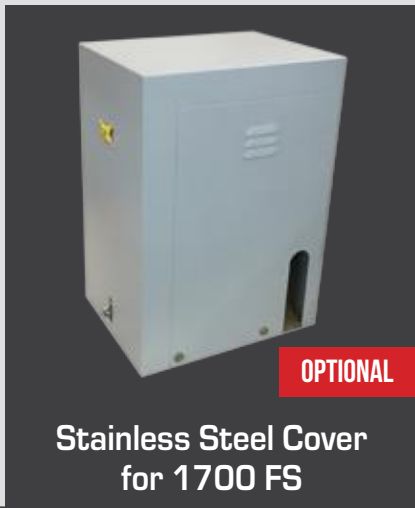

**Stainless Steel Cover
for 1700 FS**

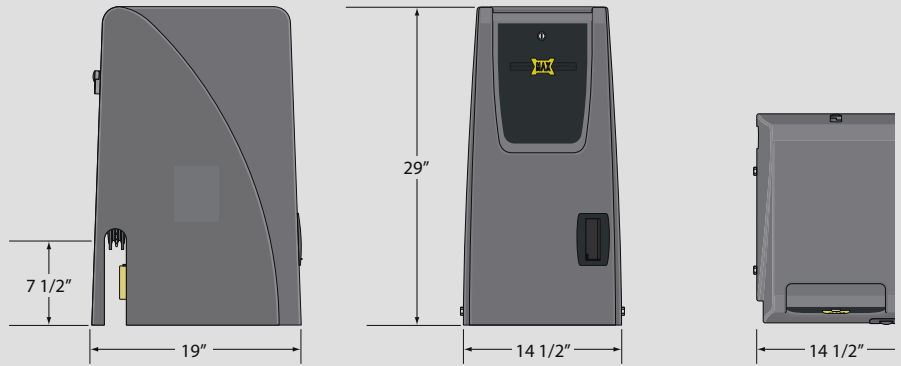

Brushless DC Motor Equivalent
to 1 1/4 HP AC Motor
6 Million Cycle
35,000 Hrs.
Life Expectancy. Integrated
Hall Effect Encoder
1 HP AC Equivalent

Heavy Duty
Gear Box
Constant Lubrication
Using Special Gear Oil

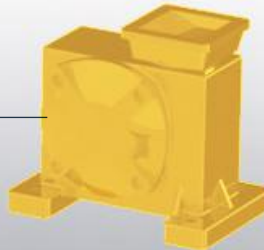

Advanced Matrix 1
Controller

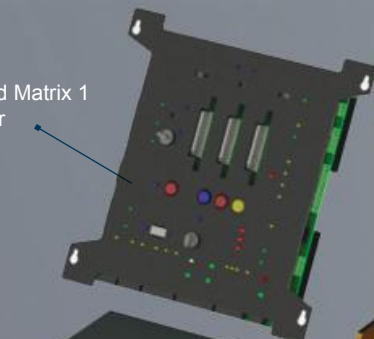

Adaptive DSP
Motor Controller



Heavy Duty 1/4"
Cold Rolled Steel
Frame Fully Welded
and Gold Zinc Plated

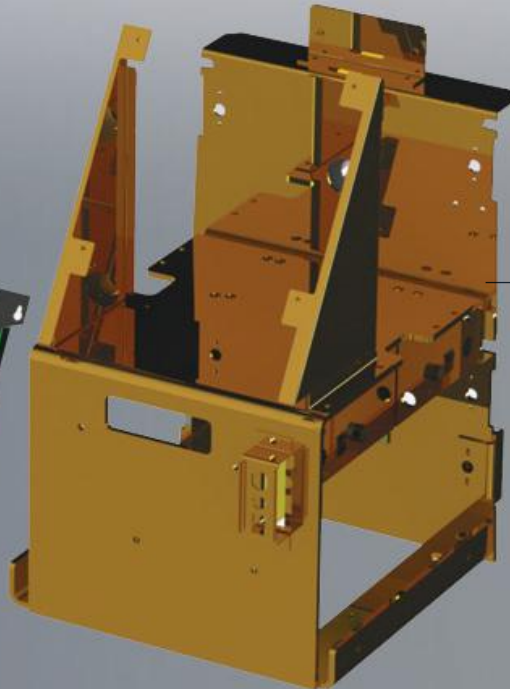

BC-7 Battery Back-up
Can Operate the Gate for
a Minimum of 100 Cycles



Gearbox

The Max Slide Gate Operator Series implements 3 various gear boxes depending on the model:

Max 1700 FS: Size 60, 20 to 1, High Efficiency, Heavy Duty Cast Iron Gearbox

The Max 1700 FS gate operator gearbox is highly efficient, producing maximum torque, maintaining a low amperage draw by reducing resistance, providing super silent operation. The rugged cast iron housing, bronze gears, and double sealed heat-treated solid shafts, have been designed by a team with over 40 years of experience in the gearbox industry.

High speed ball bearings and a synthetic oil bath keep the operator functioning flawlessly through extreme temperature ranges without need for belts, chains or pulleys; which are subject to wear, raising maintenance issues.

We invite you to compare our Maximum Controls' gearboxes to any of those used by other manufacturers.

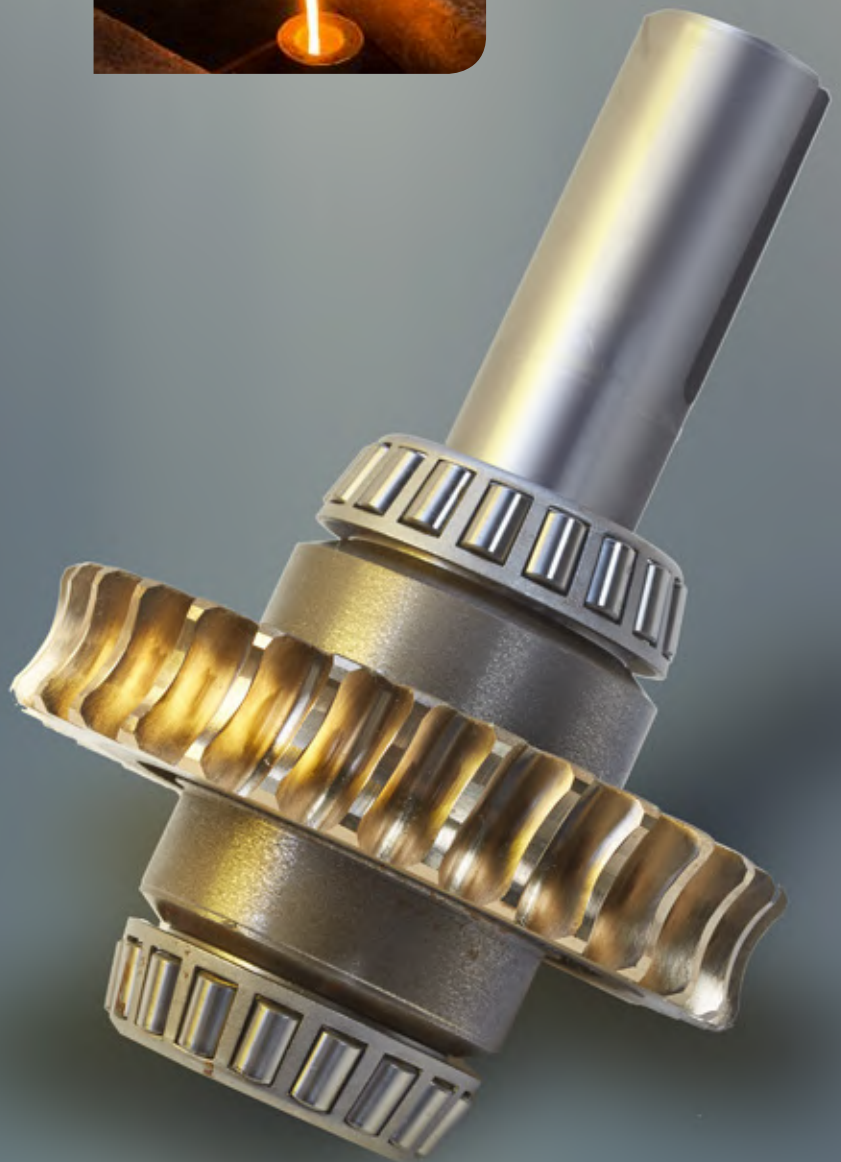

Magnetic Limit Sensing Technology

OPTIONAL FEATURE

The typical gate operator tends to lose its set position after a period of time, but Max Sliders employ technology that eliminates this problem.

The open/close limit placement for the Max Slide Operator works using magnetic sensing technology. Limit Sensor Activators (magnets) are placed on both sides of the chain to indicate the gate's "open" and "closed" position. The magnets trigger the sensors when they align.

The advantage of this method of limit sensing includes precise position sensing regardless of chain slack as well as eliminating many mechanical moving parts.

Max Slide Gate Operators' magnetic sensing technology is not the operator's sole method of determining gate limit positions. Once the open/close positions are set via Limit Sensor Activators, the primary method the operator recognizes open/close positions is with its Brushless DC Hall Effect magnetic sensing.

Hall Effect sensors, which reside in the motor, identify over thirty precise rotational positions during every inch of gate travel, utilizing the Limit Sensor Activators as an additional resource. Simultaneously employing the Hall Effect with the Limit Sensor Activators ensures the gate to open/close in the same position it was set to for years to come.

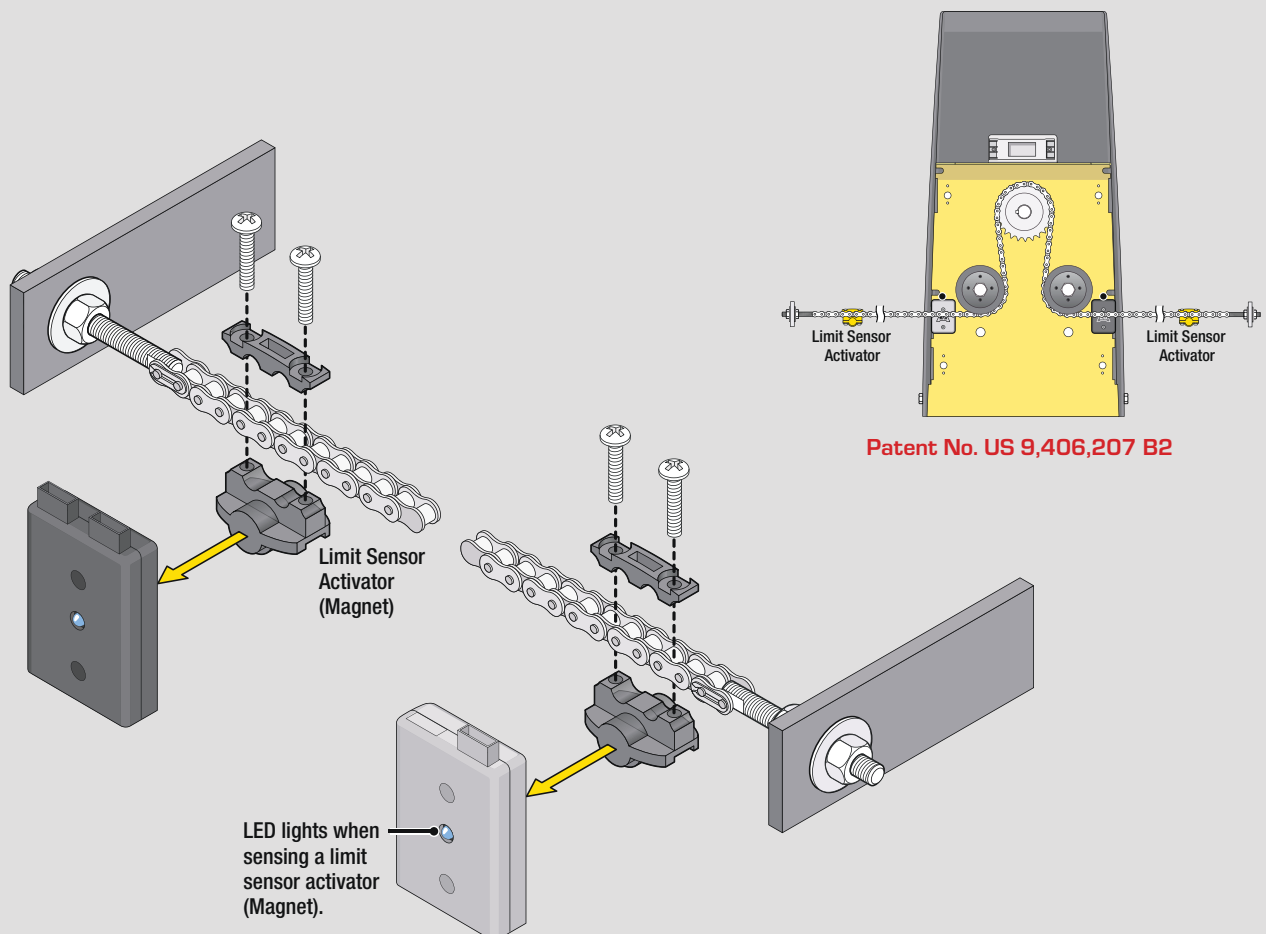

Brushless DC Motor

The brushless DC motor in the Max 1700 FS Slide Gate Operator uses “Hall Effect” magnetic sensing to identify over five thousand precise rotational positions during 90 degrees of gate movement. That’s over 50 samples per degree of gate travel. Using this positional feedback, intelligent ramp-up and ramp-down of the gate speed is employed to minimize stress on all mechanical components.

We utilize Hall Effect Sensors to know the position of the gate at any given moment, thus synchronizing the gates to open and close at the same speed. We combine this technology with a dynamic magnetic brake system which stops the gate instantly when colliding with an obstacle.

Our brushless DC motors can withstand and operate in extreme high temperatures up to 165F (+74C); this surpasses any other motor technology we know of in the market today.

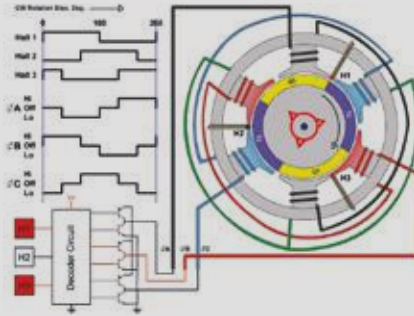

Max 1700 FS

The Max brushless DC motor’s torque is equivalent to a 1 1/4 HP AC output torque motor and can operate approximately 35,000 hours, which is about 6 million cycles. Therefore, the motor will last for decades to come. Maximum Controls stands behind our motors with a 8-year warranty.

Brushless motors controlled by DSP is the same motor technology used in advanced robotics for automobile assembly.



Motor Controller

Each Max Slide Gate Operator has a motor controller. Maximum Controls proprietary motor control technology learns the physical characteristics of a gate in order to control motion with maximum efficiency and speed. The adaptive motor control of the Max Slide Gate Operator also facilitates precision synchronization of two gates that might not be of equal weight or length. In addition to communicating with two motor controllers, a single Matrix 1 logic board allows for variable speed control within learned speed parameters.

The motor controller, using DSP technology, monitors all currents and voltages enabling 16 programmable levels of electronic obstruction sensing.



ADVANTAGES OF BRUSHLESS DC MOTOR

FEATURE	BRUSHED DC MOTORS	BRUSHLESS DC MOTOR MAX
Commutation	Mechanical	Electrical
Maintenance	High	Very Low
Electronic Noise EMI	High	Super Low
Life	Short	Much Longer 6,000,000 Cycles
Speed/Torque Characteristics	Moderately Flat	Flat (Enables Operation at All Speeds)
Efficiency	Medium	High
Motor Speed	Limited Speed Control	Variable Speed Control
Audible Noise	High at High Speeds Because of Brushes	Super Quiet
Drive Complexity	Inexpensive	Advanced DSP Control
Loss of Torque Due to Aging	Yes	No
Energy Consumption	Higher	Lower
Magnetic Hall Sensors	No	Yes (30 samples per inch of gate travel)
Warranty	Up to 5 Years	8 Years

Power Supply

Max Slide Gate Operator's power supply utilizes a 15 Amp torroid and power management board. The power supply is designed such that it is not overstressed under any extreme load or temperature conditions. The power supply input accepts 115 or 230 voltage via selection switch. During gate operation, the battery is not utilized while AC is present, thus preserving the life of the battery.

Input AC Power/Amps -

Switchable: 115VAC / 6 Amp, Single Phase
or 230VAC / 2 Amp, Single Phase



Magic Box

The Max MAGIC BOX feature can save thousands of dollars in trenching and costly permit fees. Unforeseen complications like rock formations or utility lines that have to be trenched around can be avoided by using the Magic Box. This feature is a power management system that does not rely on battery power and as a result the battery life is not compromised.

Because the Magic Box does not rely on the Max BC-7 as a booster, the gate remains operational regardless of whether the battery is malfunctioning or the Max BC-7 is removed. This technology is unique only to Maximum Controls.

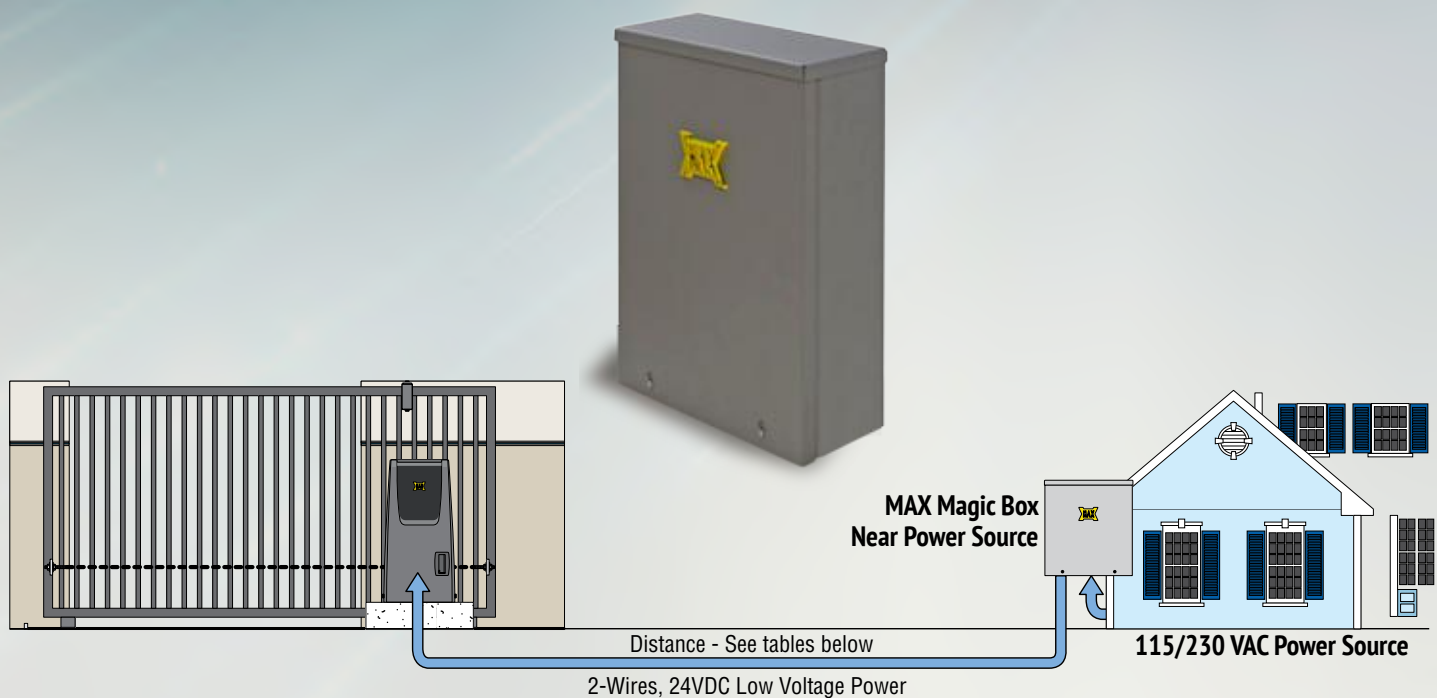

UPS Battery Backup

The Max Slide Gate Operator Series battery module, the Max BC-7, contains many features necessary for gate operation during power outages and provides safe, smart trickle charging to keep the batteries ready for emergencies or overnight in off-grid use. In addition to serving as backup power during emergencies, the BC-7 contains the electronics to properly integrate a solar panel into an off-grid configuration. Also, the BC-7 supplies an on-board solar regulator as standard equipment.

Starting with the Max BC-7 front plate, three LED indicators show the current battery status of full, half, or empty. These indicators also move sequentially to indicate that the batteries are currently charging. A battery test status button, when pressed, gives you the actual condition of the batteries. Are the batteries functioning or not? No guess work here. You will know when the batteries must be replaced. When an outage does occur, an audible beep can be switched on to indicate battery backup is in use.

On the Matrix 1 board there are three modes of battery backup functionality: "Leave gate open" will continue to open and close the gate until the battery is near empty and leave the gate in the opened position. "Leave gate closed" will continue to open and close the gate until the battery is near empty, then leave the gate closed. "Open one time" will leave a gate in the open position immediately if an outage occurs. Regardless of the battery backup mode, enough energy is left in the batteries to open the gate for an emergency vehicle.

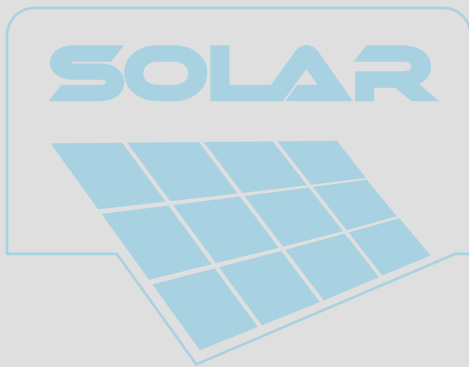

Solar Ready Power

In an off-grid configuration, in addition to the solar regulator, the Max BC-7's solar processing circuitry provides a power boost, maximizes energy harvest, and keeps a tight grip on the load control, ensuring the up to 200 watt solar panel is manipulated to its potential. Maximum Controls operators work with 80 watt panels or greater depending on the specific application. Standard 200 watt panels are supported and recommended. The solar voltage input on the BC-7 requires 24 to 35VDC.

Each Max BC-7 battery module is fitted with Yuasa batteries with an operational temperature range of -4 to 165F. These batteries offer high-energy density, sealed leak proof construction, excellent performance in float or cyclic applications, maintenance free, rechargeable, and long service life. When used with the Max Slide Gate Operator Series they offer minimum 100 cycles of duty before discharge.



BLACK BOX, LOOP MANAGEMENT, AND SECURITY

One of the primary goals of the Max Slide Gate Operator Series is to provide the most secure, easiest to maintain gate operator with higher gate speed motion and advanced loop management.

Max Slide Gate Operator Series uses non-volatile memory to continuously log performance characteristics and input/output events. A service technician can access this data via USB port to download the event history, quickly diagnosing complex or intermittent problems that traditionally have been very difficult to isolate and repair. By plugging in a USB thumb drive into the USB port, all the Max Slide Gate Operators' diagnostic history will download, working as a "Black Box" to diagnose what occurred. The Max Slide Gate Operators' event history is stored as a .TXT document which can be emailed to the factory for, if necessary, on-site diagnosis. The .TXT file is a log of the most recent 8000 events reported by each module to the central logger.

Max Slide Gate Operator Series' standard intuitive loop management system, when enabled, will discourage tailgating, increasing security for residential and high traffic installations. When the Anti-Tailgate switch is activated, any car tailgating a legitimate access will be forced to stop by a rapidly closing gate, forcing the tailgater to back up and thereby triggering the gate to close and deny unauthorized access.

When disabled, loop management will allow multi-access, with the gate opening on each successive trigger in the traditional loop management manner.



Advanced Security Features:

Tamper Alert and Gate Disable

A unique patent-pending feature is Tamper Alert, which triggers when an unauthorized chain-drop or gate movement has occurred. This feature is not found in any other operator on market today. For example, if the chain is severed or if the gate derails, Tamper Alert will initiate an audible alarm, simultaneously triggering an output relay that can be wired to your home alarm system or other devices with relay inputs such as a security camera posted at access point. (wireless relay link coming soon!).

Unique to all Maximum Controls gate operators is the Gate Disable feature which disables normal open commands from devices like a keypad box or exit loop. Gate Disable prevents someone from breaking into a property by tampering with the inputs in a keypad box or triggering the exit loop with a piece of metal to open the gate. The Gate Disable feature is useful when a gated area needs to be secured from all BUT emergency vehicles and/or other authorized vehicles. When Gate Disable is turned ON it gives the occupants 3 minutes BEFORE arming, allowing enough time to leave the property. If there is an attempt to open the gate in an unauthorized manner, the gate will not open but will sound an alarm and trigger the Tamper Alert relay.

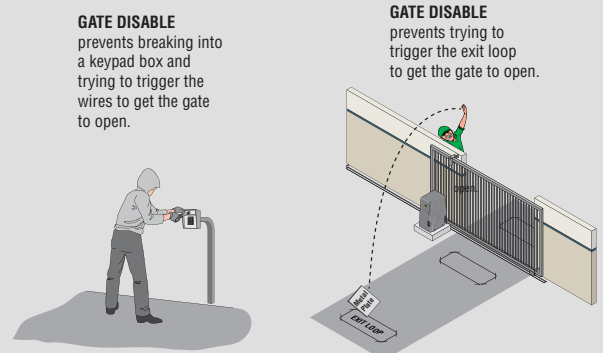

Gate Disable can be activated with a key switch or a 7-day timer.

Examples for using Gate Disable would be during vacation time at a residential home or when a business is closed and no one is available to monitor the property.

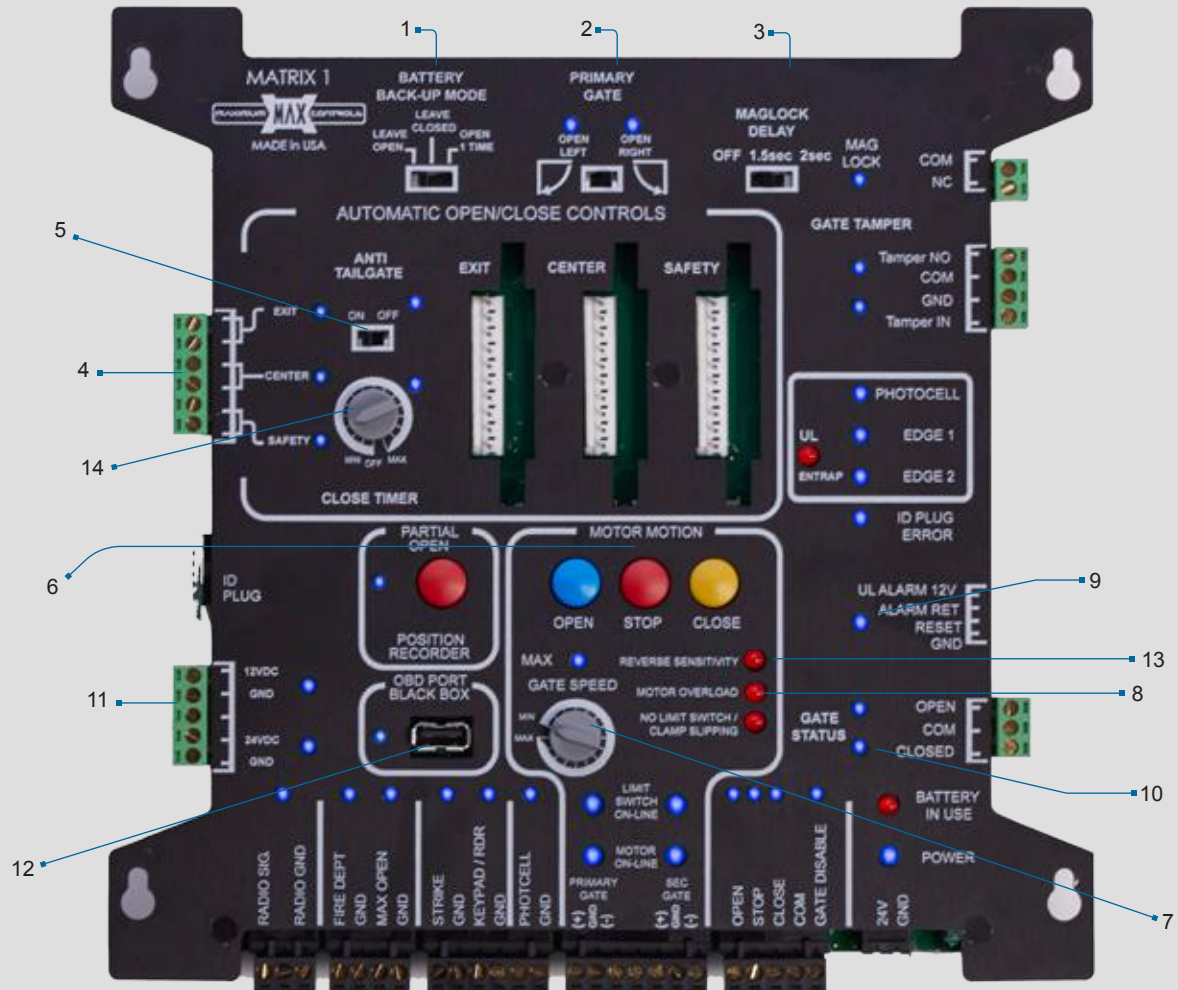

- | | |
|---|---|
| 1. Battery backup mode switch selection | 8. Motor error indicators |
| 2. Primary and secondary gate designation | 9. UL alarm output and reset |
| 3. Magnetic lock delay selectable switch with relay outputs | 10. Gate status outputs and indicators |
| 4. Loop inputs with LED indicators | 11. 12vdc and 24vdc limited DC power output |
| 5. Anti-tailgate selector switch | 12. OBD/Black Box USB port |
| 6. On-board three button station | 13. Obstruction electronic reversing |
| 7. Motor speed control | 14. 16 channels selectable timer |

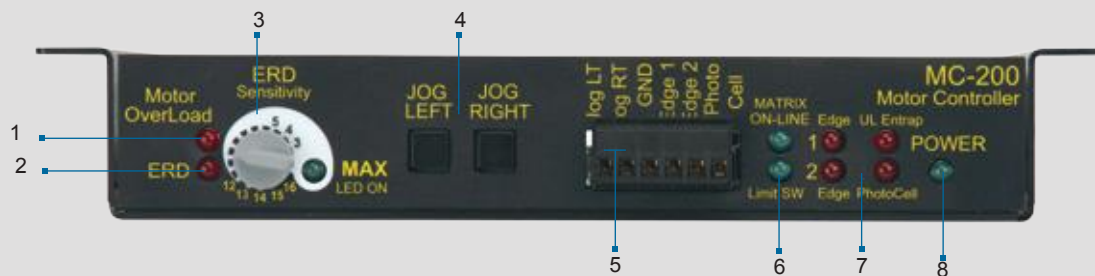

- | | |
|-------------------------------|--|
| 1. Motor overload indicator | 5. Safety and external jog switch inputs |
| 2. Detection (ERD) indicator | 6. Communication indicators |
| 3. ERD sensitivity adjustment | 7. Safety indicators |
| 4. Jog open/close switches | 8. Power indicator |

LIGHTNING PROTECTION



The Max Slide Gate Operator Series offers the most robust lightning protection available in the industry. The Max Slide Gate Operator Series protects all peripheral inputs, loop inputs, power inputs, relay outputs, and all communication lines (over 44 channels of protection) in 1/1,000,000,000 of a second. With special emphasis on power supply protection, the Max Slide Gate Operator Series is guaranteed to withstand any lightning hit more than 50 feet away. Truly protected like no other operator in the world.

Max Slide Gate Operator Series Warranty

Maximum Controls LLC ("Manufacturer") warrants the original purchaser of this product, for the purpose to which this product is originally installed, that the product is free from defect in materials and/or workmanship for a period of 8 years for the brushless DC motor and cover, 5 years for everything else with the exception of the batteries which are limited to a 1 year warranty. The performance of this product is dependent on compliance to the instructions, maintenance, operation, and testing clearly outlined in the user manual. Failure to comply completely with those instructions will void this warranty in its entirety. This warranty does not cover damage to the product caused by vandalism, water damage, direct hit lightning strike, or installation errors. This warranty does not include any labor charges that might be needed to troubleshoot, replace, or repair a problem.

If, during the limited warranty period, one of the components exhibits a defect in material and/or workmanship, please call 949-699-0220 before dismantling the product. Shipping instructions and an RMA (Return Material Authorization) number will be issued by the factory service center when contacted. Do not send any product in for service without an RMA number. Shipping charges to and from the factory service center for warranty repairs are the responsibility of the customer. Repair or replacement of any warranty items is made at the sole discretion of the Manufacturer.

ALL IMPLIED WARRANTIES FOR THE PRODUCT, INCLUDING BUT NOT LIMITED TO ANY WARRANTIES OF MERCHANTABILITY AND SUITABILITY FOR A PARTICULAR PURPOSE, ARE LIMITED TO 8 YEARS FOR THE BRUSHLESS MOTOR DC AND COVER, 5 YEARS FOR EVERYTHING ELSE WITH THE EXCEPTION TO THE BATTERIES WHICH ARE 1 YEAR. NO IMPLIED WARRANTIES WILL EXTEND BEYOND THE WARRANTIES LISTED ABOVE. Some states do not allow limitations on how long an implied warranty lasts so this limitation might not apply to you.

This limited warranty does not cover any problems with or relating to the gate, the gate hardware; including but not limited to hinges, rollers, brackets, entry devices etc. Any service call that determines the cause of a problem to be external to the product could result in a fee.

Under no circumstances shall the Manufacturer be liable for consequential, incidental or special damages arising in connection with the use, or inability to use this product. Under no circumstances will the Manufacturer's liability for breach of warranty, breach of contract, negligence or strict liability exceed the cost of the product covered herein. No person is authorized to assume for the Manufacturer any other liability in connection with the sale of this product.



MADE IN USA



www.Max.US.com

Maximum Controls LLC was founded in 2009



When you need a gate operator you can trust to keep your property secure, you can rely on the Max Slide Gate Operator Series.

Maximum Controls, headquartered in Southern California, has over thirty-three years of experience in the design and manufacturing of gate operators, telephone entry systems, and other perimeter security products for the access control industry. The team of professionals at Maximum Controls has a long and successful history as sales leaders and industry innovators. For the past four years it has been the sole focus of Maximum Controls to design the fastest, most secure, most reliable, and safest gate operators in the world.

The CEO of Maximum Controls, Alex Parsadayan, has been quoted as saying "I will not compromise quality". This philosophy has produced machines capable of great things and built to last with the highest quality components like: gold plated inputs and outputs, automobile grade electronics throughout, cold rolled steel frames, massive cast iron gearboxes, output shafts and mechanical release assemblies so solid and heavy they're sure to last for years to come.

Longevity at a competitive price—that's the key. Please compare Maximum Controls' features, warranty, and innovations when shopping for a product. Conceived as the next generation in Access Control technology, Maximum Controls has designed the most advanced gate operators ever built.

Maximum Controls LLC

949.699.0220

10530 Lawson River Ave.

Fountain Valley CA 92708

USA

Independent Dealer or Distributor